

# RAMP PRODUCT GUIDE



 **MAGLINER**®

1-800-MAGLINE (624-5463)  
[www.magliner.com](http://www.magliner.com)

# VAN WALK RAMPS

Magline Has Been Making Quality Aluminum Ramps For Over 50 Years.



Apron Model

- Twin-tooth deck for better traction when traveling in either direction
- Strong, lightweight interlocking aluminum construction makes ramps easily portable and convenient
- All apron models complete with 8" apron; 3-1/4" position stop; safety chains
- All hook models complete with two heavy duty safety hooks
- 4-1/4" Side rail height
- 3-1/4" Curb height

## APRON MODEL SPECIFICATIONS

NOMINAL LENGTHS	MAX HEIGHT RANGE	ACTUAL LENGTH	RATED CAPACITY (LBS)	2,900 SERIES				3,900 SERIES			
				P/N	OVERALL WIDTH	USABLE WIDTH	WEIGHT (LBS)	P/N	OVERALL WIDTH	USABLE WIDTH	WEIGHT (LBS)
3'	9"	36"	3,000	VR29032	28-3/4"	26-1/4"	36	VR39032	39-1/4"	37"	43
4'	12"	45"	3,000	VR29042	28-3/4"	26-1/4"	41	VR39042	39-1/4"	37"	53
5'	18"	63"	3,000	VR29052	28-3/4"	26-1/4"	54	VR39052	39-1/4"	37"	67
6'	21"	72"	2,800	VR29062	28-3/4"	26-1/4"	57	VR39062	39-1/4"	37"	76
7'	27"	90"	2,800	VR29072	28-3/4"	26-1/4"	72	VR39072	39-1/4"	37"	90
8'	31"	99"	2,500	VR29082	28-3/4"	26-1/4"	78	VR39082	39-1/4"	37"	98
9'	34"	108"	2,500	VR29092	28-3/4"	26-1/4"	86	VR39092	39-1/4"	37"	108
10'	37"	117"	2,200	VR29102	28-3/4"	26-1/4"	93	VR39102	39-1/4"	37"	114
12'	46"	144"	1,900	VR29122	28-3/4"	26-1/4"	110	VR39122	39-1/4"	37"	139
14'	52"	162"	1,600	VR29142	28-3/4"	26-1/4"	123	VR39142	39-1/4"	37"	151
16'	61"	189"	1,000	VR29162	28-3/4"	26-1/4"	147	VR39162	39-1/4"	37"	176

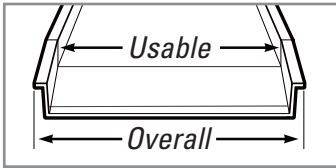

Hook Model

## HOOK MODEL SPECIFICATIONS

NOMINAL LENGTHS	MAX HEIGHT RANGE	ACTUAL LENGTH	RATED CAPACITY (LBS)	2,900 SERIES				3,900 SERIES			
				P/N	OVERALL WIDTH	USABLE WIDTH	WEIGHT (LBS)	P/N	OVERALL WIDTH	USABLE WIDTH	WEIGHT (LBS)
3'	13"	39"	3,000	VR29031	28-3/4"	26-1/4"	33	VR39031	39-1/4"	37"	41
4'	16"	48"	3,000	VR29041	28-3/4"	26-1/4"	40	VR39041	39-1/4"	37"	49
5'	22"	66"	3,000	VR29051	28-3/4"	26-1/4"	50	VR39051	39-1/4"	37"	65
6'	25"	75"	2,800	VR29061	28-3/4"	26-1/4"	56	VR39061	39-1/4"	37"	70
7'	32"	93"	2,800	VR29071	28-3/4"	26-1/4"	72	VR39071	39-1/4"	37"	90
8'	35"	102"	2,500	VR29081	28-3/4"	26-1/4"	75	VR39081	39-1/4"	37"	93
9'	38"	111"	2,500	VR29091	28-3/4"	26-1/4"	83	VR39091	39-1/4"	37"	106
10'	41"	120"	2,200	VR29101	28-3/4"	26-1/4"	89	VR39101	39-1/4"	37"	109
12'	50"	147"	1,900	VR29121	28-3/4"	26-1/4"	107	VR39121	39-1/4"	37"	133
14'	56"	165"	1,600	VR29141	28-3/4"	26-1/4"	119	VR39141	39-1/4"	37"	148
16'	66"	192"	1,000	VR29161	28-3/4"	26-1/4"	140	VR39161	39-1/4"	37"	172

\*For hook models, notches in the truck's rear apron will need to be spaced center-to-center as follows: 2900 series - 24-1/2", 3900 series - 35-1/4"

Note: Walk ramps not made for powered equipment or pallet jack use. Recommended for use with hand trucks only.

# SLIDER® & POSI-STEP® RAMPS

*Retractable Underbody Truck Ramps – Built For Tough, Long Lasting Service*

- Roll out quickly and store securely under truck
- Ship completely assembled for easy installation
- Lightweight for easy maneuverability

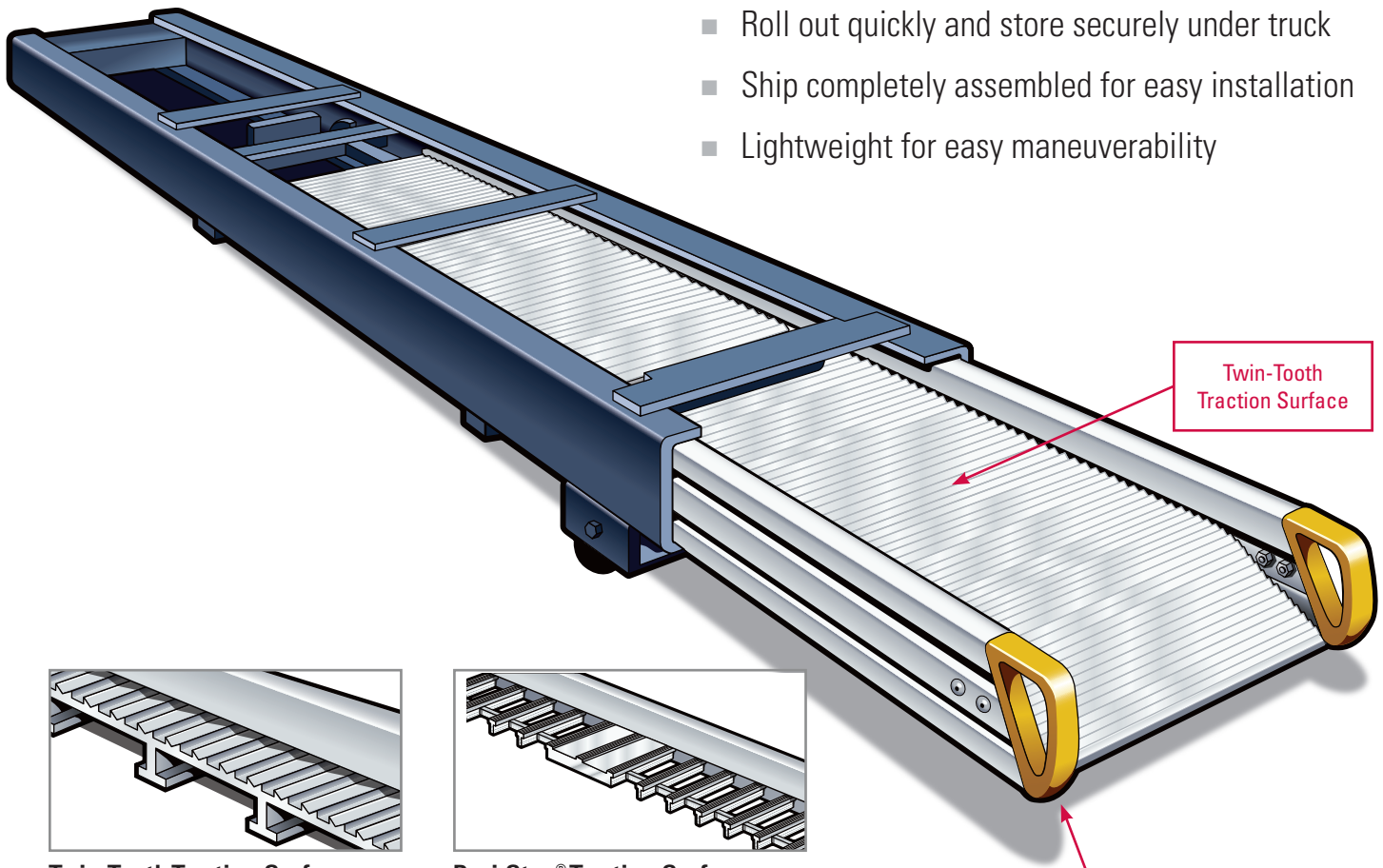

**Twin-Tooth  
Traction Surface**

**REPLACEABLE HANDLES**  
Comfortable, safe grip for  
handling and positioning ramp.

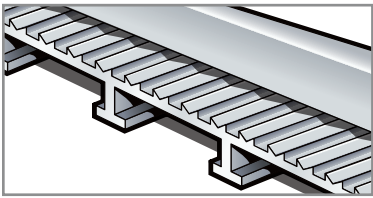

**Twin-Tooth Traction Surface**  
Safe, secure traction in either direction of travel. Twin-Tooth aluminum deck spans the entire surface area, including the sloped entry apron.

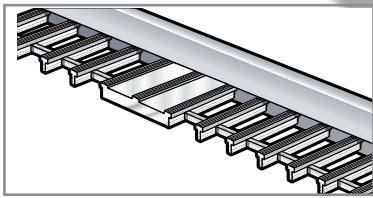

**Posi-Step® Traction Surface**  
Water, dirt and small debris do not accumulate on open I-Beam surface. Strong, high traction walk surface.

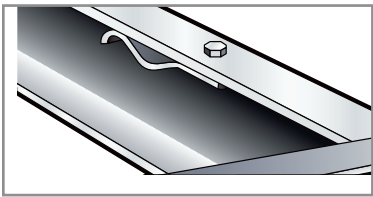

**Anti-Rattle Springs**  
Prevent ramp from bouncing or rattling when the truck is underway.

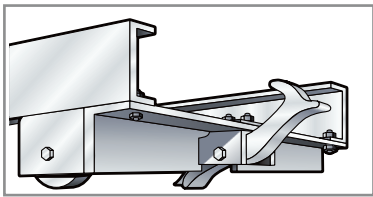

**Safety Lock**  
Holds ramp securely in place when stored under truck body. Easy to operate, simply press down on locking arm to release ramp. Lock automatically snaps back to 'secured' position when ramp is retracted for storage.

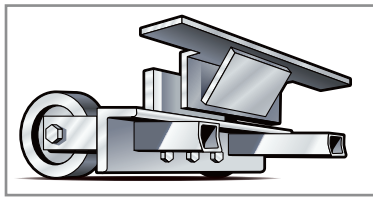

**Anti-Theft Angle Stop**  
Prevents ramp from being extended too far; reduces the risk of theft when vehicle is unattended.

*Note: Ramps not made for powered equipment or pallet jack use. Recommended for hand truck use only.*



## Easy to Operate

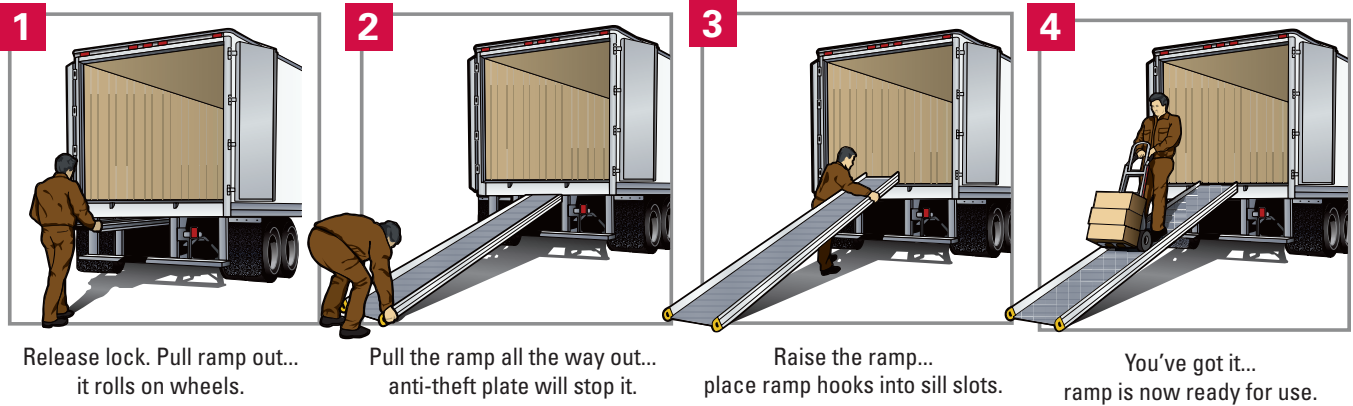

1 Release lock. Pull ramp out... it rolls on wheels.

2 Pull the ramp all the way out... anti-theft plate will stop it.

3 Raise the ramp... place ramp hooks into sill slots.

4 You've got it... ramp is now ready for use.

## Fast, Easy Installation – 5 Simple Steps

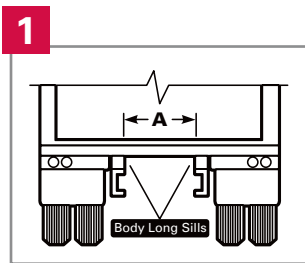

- A. Check dimensions of area where Slider Ramp is to be installed.
- B. The clearance between the body long sills and hanger bolts must be a minimum of 25- $\frac{1}{4}$ " (2,400 series); 27- $\frac{1}{2}$ " (2,600 series ramps); and 33- $\frac{1}{8}$ " (3,200 series).
- C. Minimum depth required between truck chassis and bottom of body cross members is 5- $\frac{1}{2}$ " (all series).

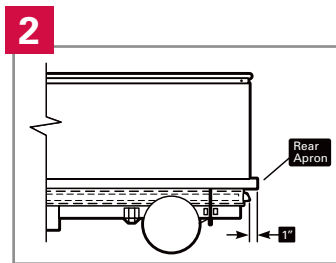

- A. Position Slider Ramp in truck opening between body long sills.
- B. Move the assembly until the ramp handles are a recommended distance of 1" inboard of rear apron. This prevents accidental damage to the Slider Ramp handles when backing up to a loading dock, etc.

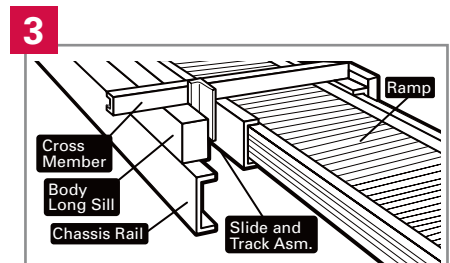

Secure the Slider Ramp slide and track assembly to the body cross members by welding short steel hanger angles starting at forward end and at intervals of approximately four (4) feet.

**IMPORTANT:** Shield ramp from weld spatter.

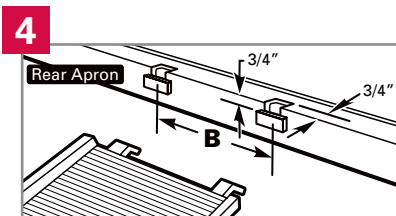

- A. Cut two notches or cutouts 1- $\frac{1}{4}$ " wide as indicated in rear apron for ramp hooks.
- B. Notches should be spaced, center to center, as follows:  
2,400 series ramps, 20- $\frac{3}{4}$ ";  
2,600 series, 23";  
3,200 series, 28- $\frac{5}{8}$ ".

### 5 Final Check

1. Fully extend ramp, check anti-theft stop function.
2. Check the fit of ramp hooks into cutouts on rear apron (see step 4 for dimensions).
3. Return ramp to latch position. If latch adjustment is required, loosen latch assembly on track members and reposition using slotted holes, re-tighten securely.
4. Attach the "Operating Instructions" label to a clean and prominent location on the back of the truck.

*Note: Ramps not made for powered equipment or pallet jack use. Recommended for hand truck use only.*

## SPECIFICATIONS

	SLIDER OR POSI		SLIDER RAMP ONLY
	2,400 SERIES	2,600 SERIES	3,200 SERIES
Track height	5- <sup>3</sup> / <sub>8</sub> "	5- <sup>3</sup> / <sub>8</sub> "	5- <sup>3</sup> / <sub>8</sub> "
Track width	25"	27- <sup>1</sup> / <sub>4</sub> "	32- <sup>7</sup> / <sub>8</sub> "
Ramp rail height	3- <sup>7</sup> / <sub>8</sub> "	3- <sup>7</sup> / <sub>8</sub> "	3- <sup>7</sup> / <sub>8</sub> "
Ramp curb height	1- <sup>9</sup> / <sub>16</sub> "	1- <sup>9</sup> / <sub>16</sub> "	1- <sup>9</sup> / <sub>16</sub> "
Ramp width outside	24- <sup>1</sup> / <sub>8</sub> "	26- <sup>3</sup> / <sub>8</sub> "	32"
Ramp usable width	22- <sup>1</sup> / <sub>8</sub> "	24- <sup>3</sup> / <sub>8</sub> "	30"

GENERAL INFORMATION											
MODELS	RAMP LENGTH	TRACK LENGTH	LOAD CAPACITY (LBS)	BODY LENGTH	TRUCK BED HEIGHT - DEGREE OF SLOPE						
					30"	34"	38"	42"	46"	50"	54"
10 Ft.	120"	141"	1500	12' Min.	14- <sup>1</sup> / <sub>2</sub> °	16- <sup>1</sup> / <sub>2</sub> °	18- <sup>1</sup> / <sub>2</sub> °	20- <sup>1</sup> / <sub>2</sub> °	—	—	—
12 Ft.	138"	159"	1500	14' Min.	12°	13- <sup>1</sup> / <sub>2</sub> °	15- <sup>1</sup> / <sub>2</sub> °	17°	18- <sup>1</sup> / <sub>2</sub> °	20- <sup>1</sup> / <sub>2</sub> °	—
14 Ft.	165"	186"	1300	16' Min.	10- <sup>1</sup> / <sub>2</sub> °	11- <sup>1</sup> / <sub>2</sub> °	13°	14- <sup>1</sup> / <sub>2</sub> °	16°	17- <sup>1</sup> / <sub>2</sub> °	18- <sup>1</sup> / <sub>2</sub> °
16 Ft.	192"	213"	900	18' Min.	9°	10°	11- <sup>1</sup> / <sub>2</sub> °	12- <sup>1</sup> / <sub>2</sub> °	14°	15°	16- <sup>1</sup> / <sub>2</sub> °

Slider Ramps Are Shipped Completely Assembled For Easy Installation.  
All Slider Ramp Parts Are Replaceable.

SPECIFICATIONS								
	10' MODELS		12' MODELS		14' MODELS		16' MODELS	
	SLIDER	POSI	SLIDER	POSI	SLIDER	POSI	SLIDER	POSI
Length of track	141"	141"	159"	159"	186"	186"	213"	213"
Length of ramp	120"	120"	138"	138"	165"	165"	192"	192"
Ramp capacity (lbs.)	1,500	1,000	1,500	1,000	1,300	1,000	900	1,000
Minimum body length	144"	144"	168"	168"	192"	192"	216"	216"

**Important:** Dimensions shown are nominal. Actual dimensions may vary by as much as  $\pm 1/2$ " (Ramp and track may be more).

## REQUIREMENTS

- A.** The clearance between the body long sills and hanger bolts must be a minimum of:
- 2400 series - 25-<sup>1</sup>/<sub>4</sub>"
  - 2600 series - 27-<sup>1</sup>/<sub>2</sub>"
  - 3200 series - 33-<sup>1</sup>/<sub>8</sub>"

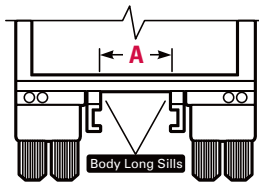

- B.** Slider and Posi-Step ramps require notches in the rear apron of the truck. Notches will need to be spaced, center to center, as follows:
- 2400 series - 20-<sup>3</sup>/<sub>4</sub>"
  - 2600 series - 23"
  - 3200 series - 28-<sup>5</sup>/<sub>8</sub>"

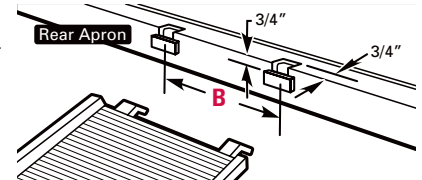

## OPTIONS



### Lift Assist

Reduces strain on operators by decreasing weight lifted when positioning ramp for use. Powered by two gas cylinders, the ramp adjusts easily for different chassis heights. The Lift Assist may be factory installed or field retrofit.

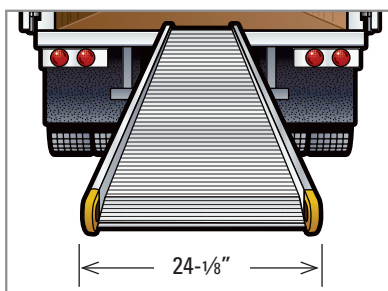

**Downsized Truck Chassis**  
2400 Series

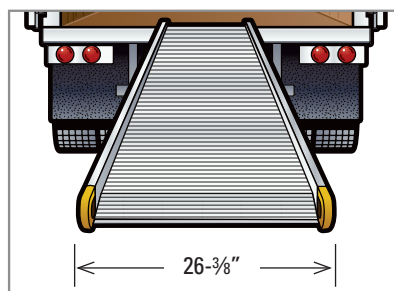

**Standard Truck Chassis**  
2600 Series

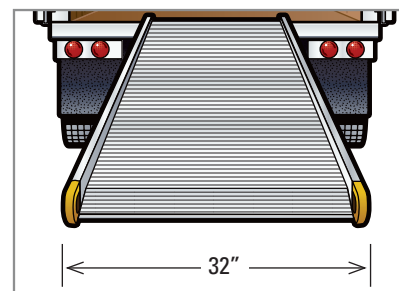

**Trailer & Wide Truck Chassis**  
3200 Series

*Note: Ramps not made for powered equipment or pallet jack use. Recommended for hand truck use only.*

# RAMP LENGTH GUIDE

DOCK OR TRUCK BED HEIGHT <i>in Inches</i>	RAMP LENGTH SHOWN IN FEET AND INCHES							
	6' (72")	7' (84")	8' (96")	9' (108")	10' (120")	12' (144")	14' (168")	16' (192")
20" (1.6')	16.5°	14.0°	12.0°	10.5°	9.5°	7.5°	6.5°	5.5°
22" (1.8')	17.5°	15.0°	13.5°	11.5°	10.5°	9.0°	7.5°	6.5°
24" (2')	19.5°	16.5°	14.5°	13.0°	11.5°	9.5°	8.0°	7.5°
26" (2.2')	21.5°	18.0°	15.5°	14.0°	12.5°	10.5°	9.0°	8.0°
28" (2.3')	22.5°	19.5°	17.0°	15.0°	13.5°	11.0°	9.5°	8.5°
30" (2.5')			18.0°	16.0°	14.5°	12.0°	10.5°	9.0°
32" (2.7')			19.5°	17.0°	15.5°	13.0°	11.0°	9.5°
34" (2.8')				18.5°	16.5°	13.5°	11.5°	10.0°
36" (3')				19.5°	17.5°	14.5°	12.5°	11.0°
38" (3.2')					18.5°	15.5°	13.0°	11.5°
40" (3.3')					19.5°	16.0°	14.0°	12.0°
42" (3.5')						17.0°	14.5°	12.5°
44" (3.7')						18.0°	15.0°	13.5°
46" (3.8')						18.5°	16.0°	14.0°
48" (4')						19.5°	16.5°	14.5°
50" (4.2')							17.5°	15.0°
52" (4.3')							18.0°	15.5°
54" (4.5')							18.5°	16.5°
56" (4.7')							19.5°	17.0°
58" (4.8')							20.0°	17.5°
60" (5')								18.5°